



DURA BIKE LOCKER™

A DIVISION OF HANNAN SPECIALTIES

PRODUCT

X301V SINGLE BIKE LOCKER

MATERIALS

Molded fiberglass reinforced plastic
E-glass and polyester resin at 35% ratio

POWDER COAT OPTIONS

*(For Bike Lockers and Racks) Anti-graffiti clear coat available

-  Tan
-  Medium Gray

LOCK TYPE

- Pad Lock Handle**
Pad Lock Not Included



- T Handle**
Keys Included



- U Lock**
Requires Pad Lock or T Handle

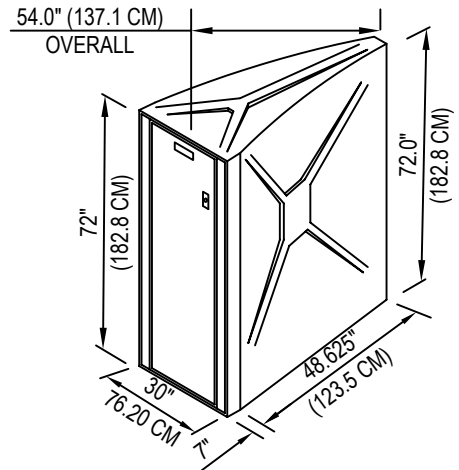
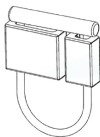

ISOMETRIC

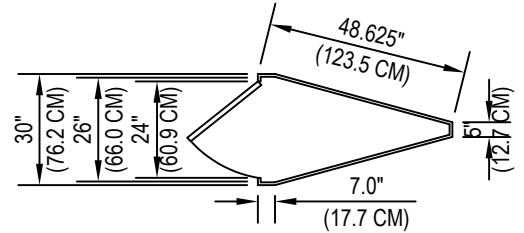

PLAN VIEW

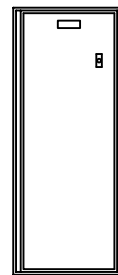

END VIEW

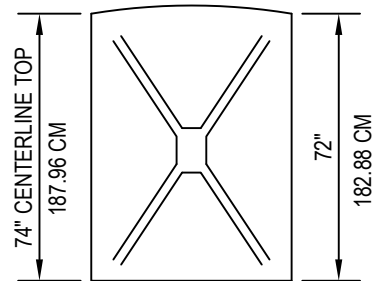

SIDE VIEW

*** Standard locker lead times depend on color, quantity, and configuration. Contact your Dura Bike Locker sales rep to insure lead time meets your schedule.

Locker Quantity: _____
 Bank Configuration: _____
 Stackable (Yes/No): _____
 Approved Date: _____
 Approved Signature: _____



DURA BIKE LOCKER™

A DIVISION OF HANNAN SPECIALTIES
Made In The Usa

CUSTOMIZATION

We offer many ways to customize your bike locker installation, like the following options:

Door Perforations

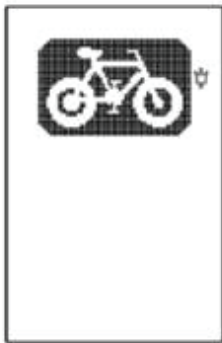

Upper Bike Icon

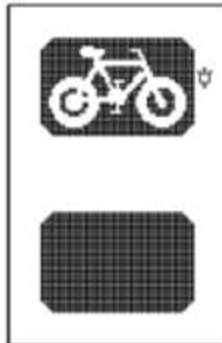

Upper Bike Icon
w/ Lower Perforation

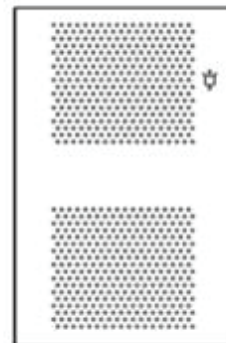

Round Perforations

Wall Perforations - Bike Icon, Obround Strip, or even custom laser cut Logos)



Bike Icon



Solid Wall



Laser Cut Logo

Custom Vinyl Logos - A great way to personalize your lockers

